

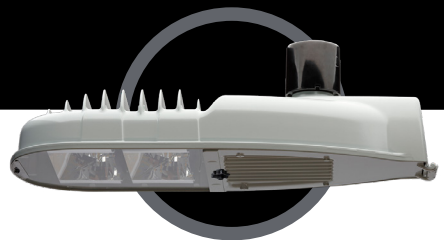

Evolve[®] LED Roadway Lighting

ERLC-ERL1-ERL2



GE current
a Daintree company

Evolve® LED Roadway Lighting

Cobra Head (ERLC)



Project Name _____

Date _____ Type _____

Notes _____

The **Evolve®** LED Roadway ERLC Luminaire is optimized utilizing advanced LED reflective optical system for local, collector and major roadways. The modern design incorporates the heat sink directly into the unit for heat transfer to prolong LED life.

CONSTRUCTION

Housing:	Aluminum die cast enclosure casting integral heat sink for maximum heat transfer
Lens:	Impact resistant tempered glass
Paint:	Corrosion resistant powder paint, ≥ 2.0 mil thickness (RAL & custom colors available) Standard = Black, Dark Bronze, Gray, White Optional = Coastal Finish
Weight:	8.5 lbs (5.6 kgs)

OPTICAL SYSTEM

Lumens:	2,000 - 7,000
Distribution:	Type II Narrow, II/III ³ , III, V
Efficacy:	110-143 LPW
CCT:	2700K, 3000K, 4000K & 5000K
CRI:	≥ 70

ELECTRICAL

Input Voltage:	120-277V (no 347-480V)
Input Frequency:	50/60Hz
Power Factor:	$\geq 90\%$ at rated watts
Total Harmonic Distortion:	$\leq 20\%$ at rated watts

SURGE PROTECTION*

Standard	Optional
10kV/5kA	Secondary 10kV/5kA (R Option) or Secondary 20kV/10kA (T Option)

*Per ANSI C136.2-2018

LUMEN MAINTENANCE

Projected Lxx per IES TM-21-11 at 25°C

Lumen Codes	Distributions	LXX(10K) @ Hours		
		25,000 HR	50,000 HR	60,000 HR
02,03,04,05	A5, B5, C5	L97	L93	L92
06	A5, B5, C5	L96	L91	L89
07	A5, B5, C5	L95	L89	L87

Lumen Codes	Distributions	LXX(10K) @ Hours		
		25,000 HR	50,000 HR	60,000 HR
02,03,04,05	V4	L96	L93	L93
06	V4	L94	L90	L88

Note: Projected Lxx based on LM80 ($\geq 10,000$ hour testing). Accepted Industry tolerances apply to initial luminous flux and lumen maintenance measurements.

RATINGS

Operating Temperature:	-40°C to 50°C
Vibration:	3G per ANSI C136.31-2018
LM-79:	Testing in accordance with IES Standards

CONTROLS

Dimming:	Standard - 0-10V Optional - DALI (Option U)
Sensors:	Photo Electric Sensors (PE) available LightGrid Compatible

WARRANTY

5 Year (Standard)

10 Year (Optional)

Evolve® LED Roadway Lighting

Cobra Head (ERLC)

Catalog Logic

Project Name _____

Date _____ Type _____

Notes _____

ERLC

PROD. ID	VOLTAGE	LUMENS	DISTRIBUTION	CCT	CONTROLS PER ANSI C136.41	COLOR	OPTIONS
E = Evolve	0 = 120-277 ¹	02 ²	A5 = II Narrow	27 = 2700K ⁴	A = 7-Pin Receptacle	BLCK = Black	B = Tether
R = Roadway	8 = 120-240	03	B5 = Type II/III ³	30 = 3000K ⁴	D = 7-Pin Receptacle with Shorting Cap	DKBZ = Dark Bronze	C1 = Captive Door
L = Local		04	C5 = Type III	40 = 4000K	E = 7 Pin Receptacle with Long Life non-Dimming PE Control	GRAY = Gray	F = Fusing
C = Compact	1 = 120	05	V4 = Type V	50 = 5000K		WHTE = White	G = Internal Bubble Level
	2 = 208	06			Note: 0-10V control standard unless DALI Option "U" requested		L = Tool-Less Entry
	3 = 240	07					M1 = MagnaPak ⁸
	4 = 277						R = Secondary 10kV/5kA SPD
							T = Secondary 20kV/10kA SPD
							U = DALI Programmable ⁵
							V1 = Field Adjustable Module ^{1,7}
							Y = Coastal Finish ⁶
							XXX = Special Options

¹ Not Available with Fusing

² Lumen choice only offered for 120-240V

³ See ISO plots of the B5 Distribution

⁴ Select 2700K or 3000K CCT for IDA approved units

⁵ Compatible with LightGrid

⁶ Recommended for installations within 750 feet from coast. Lead time varies, check with factory.

⁷ Not available with DALI "U" option

⁸ Option M1 provides for MagnaPak – 40 Fixtures per MagnaPak Container. Single Pack box is standard

SUGGESTED HID REPLACEMENT

- Approximately 2,000 - 7,000 lumens to replace 50-100W HPS Cobra-head

Note: actual replacement lumens may vary based upon mounting height, pole spacing, design criteria, etc.

Previous	Optical Pattern	Latest	New Optical Pattern
A3	Type II Narrow	A5	Type II Narrow
B3	Type II Wide	B5	Type II/III
C3	Type III	C5	Type III
N/A	Type V	V4	Type V

The information above is designed to provide a guideline to select the correct luminaire for a roadway application. The best and most accurate way to ensure the proper design is by doing a lighting layout.

Evolve® LED Roadway Lighting

Cobra Head (ERLC)

Spec Tables

Project Name _____

Date _____ Type _____

Notes _____

LUMEN OUTPUT	DIST.	LUMENS			WATTAGE	BUG RATINGS		
		4000K/5000K	3000K	2700K	120-277V	4000K/5000K	3000K	2700K
02	A5	2000	1940	1760	15	B1-U0-G1	B1-U0-G1	B1-U0-G1
	B5	2000	1940	1760	15	B1-U0-G1	B1-U0-G1	B1-U0-G1
	C5	2000	1940	1760	15	B1-U0-G1	B1-U0-G1	B1-U0-G1
	V4	1990	1950	1890	15	B1-U0-G0	B1-U0-G0	B1-U0-G0
03	A5	3000	2910	2640	22	B1-U0-G1	B1-U0-G1	B1-U0-G1
	B5	3000	2910	2640	22	B1-U0-G1	B1-U0-G1	B1-U0-G1
	C5	3000	2910	2640	22	B1-U0-G1	B1-U0-G1	B1-U0-G1
	V4	3100	3030	2950	23	B1-U0-G0	B1-U0-G0	B1-U0-G0
04	A5	4000	3880	3520	28	B1-U0-G1	B1-U0-G1	B1-U0-G1
	B5	4000	3880	3520	28	B1-U0-G1	B1-U0-G1	B1-U0-G1
	C5	4000	3880	3520	28	B1-U0-G1	B1-U0-G1	B1-U0-G1
	V4	4030	3940	3840	32	B2-U0-G0	B2-U0-G0	B2-U0-G0
05	A5	5000	4850	4400	36	B1-U0-G1	B1-U0-G1	B1-U0-G1
	B5	5000	4850	4400	36	B1-U0-G1	B1-U0-G1	B1-U0-G1
	C5	5000	4850	4400	36	B1-U0-G2	B1-U0-G2	B1-U0-G1
	V4	5200	5090	4950	43	B2-U0-G1	B2-U0-G1	B2-U0-G1
06	A5	6000	5820	5280	46	B2-U0-G2	B1-U0-G1	B1-U0-G1
	B5	6000	5820	5280	46	B1-U0-G2	B1-U0-G2	B1-U0-G2
	C5	6000	5820	5280	46	B1-U0-G2	B1-U0-G2	B1-U0-G2
	V4	6350	6220	6050	55	B2-U0-G1	B2-U0-G1	B2-U0-G1
07	A5	7000	6790	6160	56	B2-U0-G2	B2-U0-G2	B2-U0-G2
	B5	7000	6790	6160	56	B1-U0-G2	B1-U0-G2	B1-U0-G2
	C5	7000	6790	6160	56	B1-U0-G2	B1-U0-G2	B1-U0-G2

For additional information on ERLC IES files, please click one of the following links:

[Non-Shielded](#)

[Shielded](#)

Evolve® LED Roadway Lighting

Cobra Head (ERLC)

Photometric Plots

Project Name _____

Date _____ Type _____

Notes _____

ERLC
Type II Narrow

5,000 Lumens
4000K
ERLC_05A540__IES

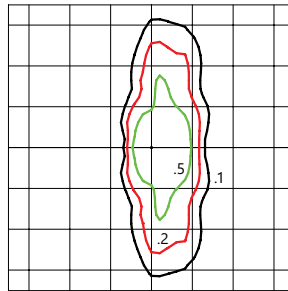

- Mounting Height at 30'
- Initial Footcandle at Grade

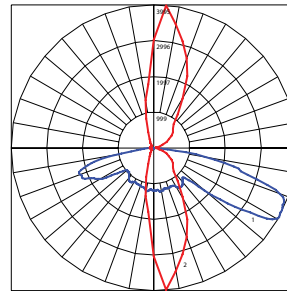

- Vertical plane at max Cd horiz. angle
- Horizontal cone at max Cd vert. angle

ERLC
Type II/III³

5,000 Lumens
4000K
ERLC_05B540__IES

³ This optic is designed to address a Roadway Photometric Application and may classify as Type II or III.

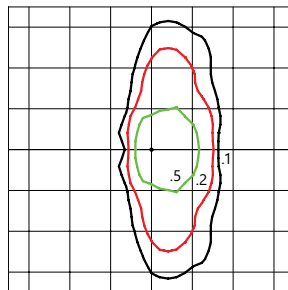

- Mounting Height at 30'
- Initial Footcandle at Grade

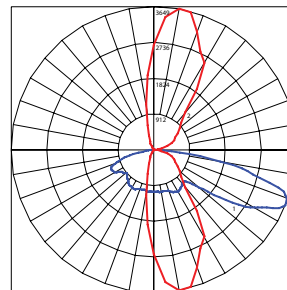

- Vertical plane at max Cd horiz. angle
- Horizontal cone at max Cd vert. angle

ERLC
Type III

5,000 Lumens
4000K
ERLC_05C540__IES

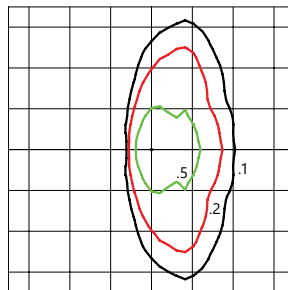

- Mounting Height at 30'
- Initial Footcandle at Grade

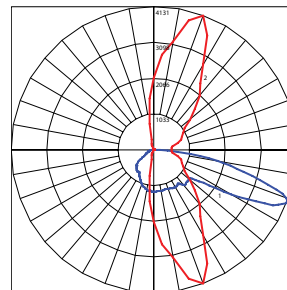

- Vertical plane at max Cd horiz. angle
- Horizontal cone at max Cd vert. angle

ERLC
Type V

5,200 Lumens
4000K
ERLC_05V440__IES

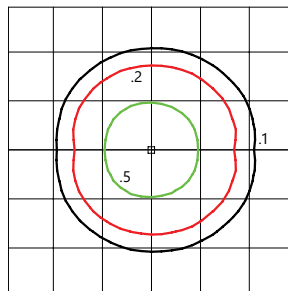

- Mounting Height at 30'
- Initial Footcandle at Grade

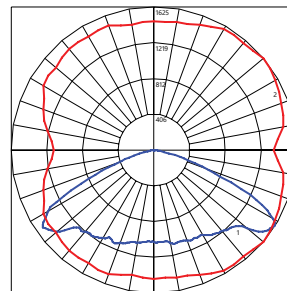

- Vertical plane at max Cd horiz. angle
- Horizontal cone at max Cd vert. angle

Evolve® LED Roadway Lighting

Cobra Head (ERLC)

Mounting & Accessories

Project Name _____

Date _____ Type _____

Notes _____

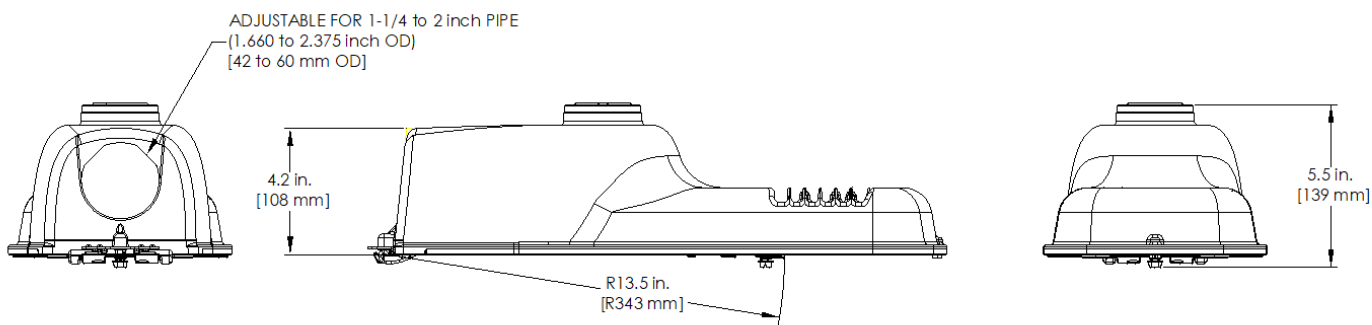
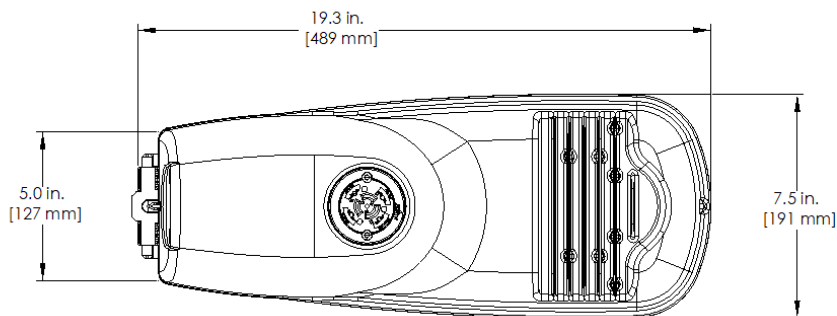

MOUNTING

- Adjustable for 1.25 to 2 in. nominal mounting pipe
- Integral diecast mounting pipe stop
- Slipfitter with +/- 5 degrees of leveling adjustment

EFFECTIVE PROJECTED AREA

- 0.3 sq ft max (0.029 sq m)

WEIGHT

- Approximate net weight: 8.5 lbs (3.8 kgs)

ACCESSORIES

SAP Number	Part Number	Description
93029237	PED-MV-LED-7	ANSI C136.41 Dimming PE, 120-277V
93029238	PED-347-LED-7	ANSI C136.41 Dimming PE, 347V
93029239	PED-480-LED-7	ANSI C136.41 Dimming PE, 480V
28299	PEC0TL	Standard 120-277V
XXXXXX	PECHTL	Standard 347-480V
73251	SCCL-PECTL	Shorting Cap

See pages 22 & 23 for more detailed information on ERLC Shields.

NETWORKED LIGHTING CONTROL



Current's **LightGrid™** Outdoor Lighting Control System is designed for Street and Roadway Applications. It enables remote monitoring, control, and asset management of a single fixture or a group of fixtures through a web enabled Central Management System.

Evolve® LED Roadway Lighting

Cobra Head (ERL1)



Project Name _____

Date _____ Type _____

Notes _____

The **Evolve®** LED Roadway ERL1 Luminaire is optimized utilizing advanced LED reflective optical system for local, collector and major roadways. The modern design incorporates the heat sink directly into the unit for heat transfer to prolong LED life.

CONSTRUCTION

Housing:	Aluminum die cast enclosure casting integral heat sink for maximum heat transfer
Lens:	Impact resistant tempered glass
Paint:	Corrosion resistant powder paint, ≥ 2.0 mil thickness (RAL & custom colors available) Standard = Black, Dark Bronze, Gray, White Optional = Coastal Finish
Weight:	12.4 lbs (5.6 kgs)

OPTICAL SYSTEM

Lumens:	2,000 - 15,700
Distribution:	Type II ,III, IV, Type II Narrow and Type II Enhanced Backlight
Efficacy:	111-140 LPW
CCT:	2700K, 3000K, 4000K and 5000K
CRI:	≥ 70

ELECTRICAL

Input Voltage:	120-277V or 347-480V
Input Frequency:	50/60Hz
Power Factor:	$\geq 90\%$ at rated watts
Total Harmonic Distortion:	$\leq 20\%$ at rated watts

SURGE PROTECTION*

Standard	Optional
10kV/5kA	Secondary 10kV/5kA (R Option) or Secondary 20kV/10kA (T Option)

*Per ANSI C136.2-2018

RATINGS

Operating Temperature:	-40°C to 50°C
Vibration:	3G per ANSI C136.31-2018
LM-79:	Testing in accordance with IES Standards

CONTROLS

Dimming:	Standard-0-10V Optional-DALI (Option U)
Sensors:	Photo Electric Sensors (PE) available LightGrid Compatible

WARRANTY

5 Year (Standard)

10 Year (Optional)

Evolve® LED Roadway Lighting

Cobra Head (ERL1)

Catalog Logic

Project Name _____

Date _____ Type _____

Notes _____

ERL1

PROD. ID	VOLTAGE	LUMENS	DISTRIBUTION ³	CCT	CONTROLS PER ANSI C136.41	COLOR	OPTIONS
E = Evolve	0 = 120-277 ^{1,2}	02 ²	A5 = Type II Narrow	27 = 2700K ⁴	A = 7-Pin Receptacle	GRAY = Gray	A = 4 Bolt Slipfitter ⁵
R = Roadway	H = 347-480 ¹	03	B5 = Type II	30 = 3000K ⁴	D = 7-Pin Receptacle with Shorting Cap	BLCK = Black	B = Tether
L = Local	1 = 120	04	C5 = Type III	40 = 4000K	E = 7-Pin Receptacle with non-dimming Long Life PE	DKBZ = Dark Bronze	F = Fusing
1 = Single Module	2 = 208	05	D5 = Type IV	50 = 5000K	Note: 0-10V standard	WHTE = White	G = Internal Bubble Level
	3 = 240	06	E5 = Type II Enhanced Back Light				I = Optional IP66 Optical Enclosure
	4 = 277	07					L = Tool-Less Entry
	8 = 120-240 ^{1,11}	08					R = Secondary 10kV/5kA SPD
	5 = 480	09					T = Secondary 20kV/10kA SPD
	D = 347	10					U = DALI Programmable ^{6,7}
		11					V1 = Field Adjustable Module ¹⁰
		12					X = Single Pack ⁸
		13					Y = Coastal Finish ⁹
		14					XXX = Special Options
	15						
	16						

¹ Fusing requires discrete voltage.

² 02 Lumen Level, Voltage options 1, 2, 3 and 8 only

³ Nominal IES Type and classing subject to typical variation, individual units may differ

⁴ Select 2700K or 3000K CCT for IDA approved units

⁵ Lead time varies, contact Factory

⁶ Compatible with LightGrid

⁷ Not available in 347V, 480V or 347-480V for Lumen Output Levels 08-16

⁸ Option provides single pack box per fixture. Standard packaging = 23 units per MagnaPak Container

⁹ Recommended for installations within 750 feet from coast. Lead time varies, check with factory.

¹⁰ Not available with DALI "U" option

¹¹ Only available with 02 Lumen Code

SUGGESTED HID REPLACEMENT

Approximately 2,000-3,000 lumens to replace 50W-70W HPS Cobra-head

Approximately 4,000-5,000 lumens to replace 100W HPS Cobra-head

Approximately 7,000-9,000 lumens to replace 150W HPS Cobra-head

Approximately 9,000-12,000 lumens to replace 200W HPS Cobra-head

Approximately 12,000-16,000 lumens to replace 250W HPS Cobra-head

Note: actual replacement lumens may vary based upon mounting height, pole spacing, design criteria, etc.

Evolve® LED Roadway Lighting

Cobra Head (ERL1)

Spec Tables

Project Name _____

Date _____ Type _____

Notes _____

LUMEN OUTPUT	DIST.	TYPICAL INITIAL LUMENS			WATTAGE		BUG RATINGS			TM-21-11 LXX (≥10k) @ HOURS		
		5000K/4000K	3000K	2700K	120V 277V	347V 480V	5000K/4000K	3000K	2700K	25,000 HR	50,000 HR	60,000 HR
02	A5	2000	1900	1900	15*	N/A	B1-U0-G1	B1-U0-G1	B1-U0-G1	96	94	93
	B5						B1-U0-G1	B1-U0-G1	B1-U0-G1			
	C5						B0-U0-G1	B0-U0-G1	B0-U0-G1			
	D5						B0-U0-G1	B0-U0-G1	B0-U0-G1			
	E5						B1-U0-G1	B1-U0-G1	B1-U0-G1			
03	A5	3000	2900	2800	22	26	B1-U0-G1	B1-U0-G1	B1-U0-G1	96	94	93
	B5						B1-U0-G1	B1-U0-G1	B1-U0-G1			
	C5						B1-U0-G1	B1-U0-G1	B1-U0-G1			
	D5						B1-U0-G1	B1-U0-G1	B1-U0-G1			
	E5						B1-U0-G1	B1-U0-G1	B1-U0-G1			
04	A5	4000	3900	3800	29	33	B1-U0-G1	B1-U0-G1	B1-U0-G1	96	94	93
	B5						B1-U0-G1	B1-U0-G1	B1-U0-G1			
	C5						B1-U0-G1	B1-U0-G1	B1-U0-G1			
	D5						B1-U0-G1	B1-U0-G1	B1-U0-G1			
	E5						B1-U0-G1	B1-U0-G1	B1-U0-G1			
05	A5	5000	4900	4700	37	39	B1-U0-G1	B1-U0-G1	B1-U0-G1	96	94	93
	B5						B1-U0-G1	B1-U0-G1	B1-U0-G1			
	C5						B1-U0-G1	B1-U0-G1	B1-U0-G1			
	D5						B1-U0-G1	B1-U0-G1	B1-U0-G1			
	E5						B2-U0-G2	B1-U0-G1	B1-U0-G1			
06	A5	6000	5800	5700	46	49	B2-U0-G2	B2-U0-G2	B2-U0-G2	96	94	93
	B5						B1-U0-G1	B1-U0-G1	B1-U0-G1			
	C5						B1-U0-G2	B1-U0-G2	B1-U0-G2			
	D5						B1-U0-G2	B1-U0-G2	B1-U0-G2			
	E5						B2-U0-G2	B2-U0-G2	B2-U0-G2			
07	A5	7000	6700	6200	50	51	B2-U0-G2	B2-U0-G2	B2-U0-G2	99	98	98
	B5						B1-U0-G2	B1-U0-G2	B1-U0-G1			
	C5						B1-U0-G2	B1-U0-G2	B1-U0-G2			
	D5						B1-U0-G2	B1-U0-G2	B1-U0-G2			
	E5						B2-U0-G2	B2-U0-G2	B2-U0-G2			
08	A5	8000	7600	7100	59		B2-U0-G2	B2-U0-G2	B2-U0-G2	99	98	98
	B5						B2-U0-G2	B2-U0-G2	B1-U0-G2			
	C5						B1-U0-G2	B1-U0-G2	B1-U0-G2			
	D5						B1-U0-G2	B1-U0-G2	B1-U0-G2			
	E5						B2-U0-G2	B2-U0-G2	B2-U0-G2			
09	A5	9000	8600	8000	68		B2-U0-G2	B2-U0-G2	B2-U0-G2	98	97	96
	B5						B2-U0-G2	B2-U0-G2	B2-U0-G2			
	C5						B1-U0-G2	B1-U0-G2	B1-U0-G2			
	D5						B1-U0-G2	B1-U0-G2	B1-U0-G2			
	E5						B2-U0-G2	B2-U0-G2	B2-U0-G2			

NOTE: * 120-240V only

For additional information on ERL1 IES files, please click one of the following links:

[Non-Shielded](#)

[Shielded](#)

Evolve® LED Roadway Lighting

Cobra Head (ERL1)

Spec Tables

Project Name _____

Date _____ Type _____

Notes _____

LUMEN OUTPUT	DIST.	TYPICAL INITIAL LUMENS			WATTAGE		BUG RATINGS			TM-21-11 LXX (≥10k) @ HOURS		
		5000K/4000K	3000K	2700K	120V 277V	347V 480V	5000K/4000K	3000K	2700K	25,000 HR	50,000 HR	60,000 HR
10	A5	10000	9600	8900	76	B2-U0-G2	B2-U0-G2	B2-U0-G2	94	87	84	
	B5					B2-U0-G2	B2-U0-G2	B2-U0-G2				
	C5					B2-U0-G2	B2-U0-G2	B1-U0-G2				
	D5					B1-U0-G2	B1-U0-G2	B1-U0-G2				
	E5					B3-U0-G3	B2-U0-G2	B2-U0-G2				
11	A5	11000	10500	9700	87	B3-U0-G3	B3-U0-G3	B2-U0-G2	93	85	82	
	B5					B2-U0-G2	B2-U0-G2	B2-U0-G2				
	C5					B2-U0-G2	B2-U0-G2	B2-U0-G2				
	D5					B2-U0-G2	B2-U0-G2	B1-U0-G2				
	E5					B3-U0-G3	B3-U0-G3	B3-U0-G3				
12	A5	12000	11500	11100	93	B3-U0-G3	B3-U0-G3	B3-U0-G3	96	95	94	
	B5					B2-U0-G2	B2-U0-G2	B2-U0-G2				
	C5					B2-U0-G2	B2-U0-G2	B2-U0-G2				
	D5					B2-U0-G2	B2-U0-G2	B2-U0-G2				
	E5					B3-U0-G3	B3-U0-G3	B3-U0-G3				
13	A5	13000	12400	12000	102	B3-U0-G3	B3-U0-G3	B3-U0-G3	96	94	93	
	B5					B2-U0-G2	B2-U0-G2	B2-U0-G2				
	C5					B2-U0-G3	B2-U0-G2	B2-U0-G2				
	D5					B2-U0-G2	B2-U0-G2	B2-U0-G2				
	E5					B3-U0-G3	B3-U0-G3	B3-U0-G3				
14	A5	14000	13400	13000	110	B3-U0-G3	B3-U0-G3	B3-U0-G3	95	92	91	
	B5					B2-U0-G2	B2-U0-G2	B2-U0-G2				
	C5					B2-U0-G3	B2-U0-G3	B2-U0-G3				
	D5					B2-U0-G2	B2-U0-G2	B2-U0-G2				
	E5					B3-U0-G3	B3-U0-G3	B3-U0-G3				
15	A5	15000	14400	13900	121	B3-U0-G3	B3-U0-G3	B3-U0-G3	93	88	86	
	B5					B3-U0-G3	B2-U0-G2	B2-U0-G2				
	C5					B2-U0-G3	B2-U0-G3	B2-U0-G3				
	D5					B2-U0-G2	B2-U0-G2	B2-U0-G2				
	E5					B3-U0-G3	B3-U0-G3	B3-U0-G3				
16	A5	15700	15000	14600	129	B3-U0-G3	B3-U0-G3	B3-U0-G3	91	85	83	
	B5					B3-U0-G3	B3-U0-G3	B2-U0-G2				
	C5					B2-U0-G3	B2-U0-G3	B2-U0-G3				
	D5					B2-U0-G3	B2-U0-G3	B2-U0-G2				
	E5					B3-U0-G3	B3-U0-G3	B3-U0-G3				

For additional information on ERL1 IES files, please click one of the following links:

[Non-Shielded](#)

[Shielded](#)

Evolve® LED Roadway Lighting

Cobra Head (ERL1)

Photometric Plots

Project Name _____

Date _____ Type _____

Notes _____

ERL1
Type II Narrow
 15700 Lumens
 5000K
 ERL1_16A550__IES

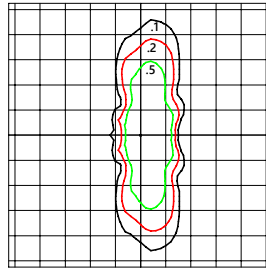

- Mounting Height at 30'
- Initial Footcandle at Grade

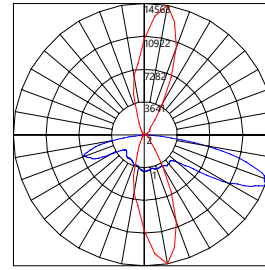

- Vertical plane at max Cd horiz. angle 80°
- Horizontal cone at max Cd vert. angle 68°

ERL1
Type II Wide
 15700 Lumens
 5000K
 ERL1_16B550__IES

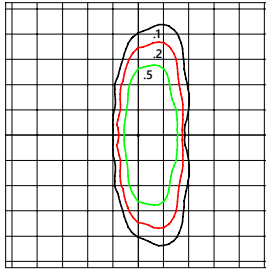

- Mounting Height at 30'
- Initial Footcandle at Grade

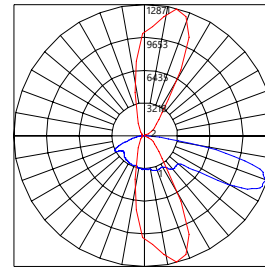

- Vertical plane at max Cd horiz angle 75°
- Horizontal cone at max Cd vert. angle 68°

ERL1
Type III
 15700 Lumens
 5000K
 ERL1_16C550__IES

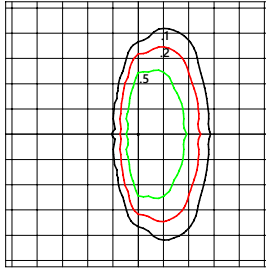

- Mounting Height at 30'
- Initial Footcandle at Grade

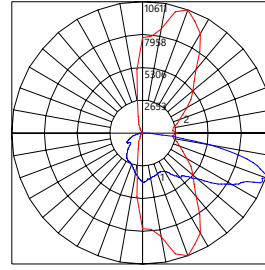

- Vertical plane at max Cd horiz angle 70°
- Horizontal cone at max Cd vert. angle 70°

ERL1
Type IV Short
 15700 Lumens
 5000K
 ERL1_16D550__IES

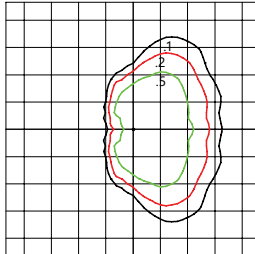

- Mounting Height at 40'
- Initial Footcandle at Grade

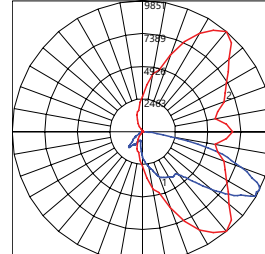

- Vertical plane at max Cd horiz angle 50°
- Horizontal cone at max Cd vert. angle 63°

ERL1
Type II Medium
 15700 Lumens
 5000K
 ERL1_16E550__IES

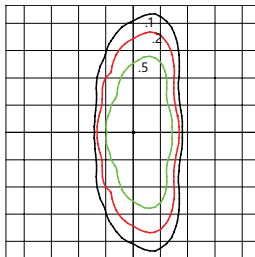

- Mounting Height at 40'
- Initial Footcandle at Grade

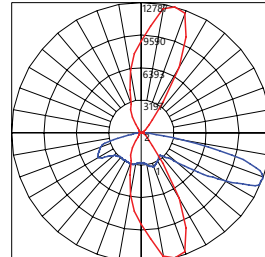

- Vertical plane at max Cd horiz angle 75°
- Horizontal cone at max Cd vert. angle 69°

ISO illuminate diagrams and polar plots are representative of the SKUs illustrated. Refer to IES files for SKU specific information.

Evolve[®] LED Roadway Lighting

Cobra Head (ERL1)

Mounting & Accessories

Project Name _____

Date _____ Type _____

Notes _____

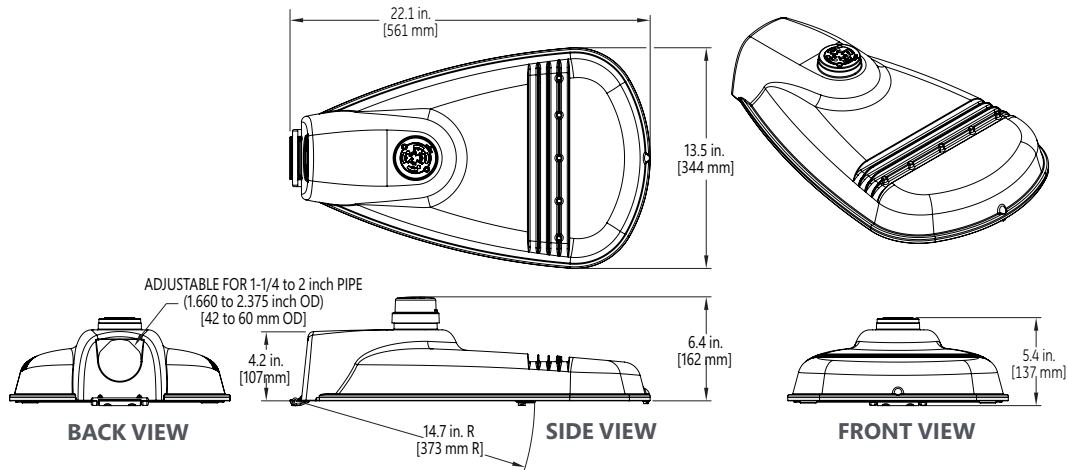

MOUNTING

- Adjustable for 1.25 to 2 in. nominal mounting pipe (1.660 to 2.375 inch OD)
- Integral diecast mounting pipe stop
- Slipfitter with +/- 5 degrees of leveling adjustment

EFFECTIVE PROJECTED AREA

- 0.5 sq ft max (0.046 sq m)

WEIGHT

- 12.4 lbs (5.6 kgs)

ACCESSORIES

SAP Number	Part Number	Description
93029237	PED-MV-LED-7	ANSI C136.41 Dimming PE, 120-277V
93029238	PED-347-LED-7	ANSI C136.41 Dimming PE, 347V
93029239	PED-480-LED-7	ANSI C136.41 Dimming PE, 480V
28299	PEC0TL	Long Life PE 120-277V
93147530	PECHTL	Long Life PE 347-480V
73251	SCCL-PECTL	Shorting Cap

NETWORK LIGHTING CONTROLS



Current's **LightGrid™** Outdoor Lighting Control System is designed for Street and Roadway Applications. It enables remote monitoring, control, and asset management of a single fixture or a group of fixtures through a web enabled Central Management System.

Evolve® LED Roadway Lighting

Cobra Head (ERL2)



Project Name _____

Date _____ Type _____

Notes _____

The **Evolve®** LED Roadway ERL2 Luminaire is optimized utilizing advanced LED reflective optical system for local, collector and major roadways. The modern design incorporates the heat sink directly into the unit for heat transfer to prolong LED life.

CONSTRUCTION

Housing:	Aluminum die cast enclosure. Casting Integral heat sink for maximum heat transfer
Lens:	Impact resistant tempered glass
Paint:	Corrosion resistant polyester powder painted, minimum 2.0 mil thickness <i>(RAL & custom colors available)</i> Standard = Black, Dark Bronze Gray, White Optional = Coastal Finish
Weight:	24.0 lbs (10.9 kgs)

OPTICAL SYSTEM

Lumens:	16,000 - 32,000
Distribution:	Type II Narrow, Type II Wide, Type III, Type IV and Type II Enhanced Back light
Efficacy:	112-140 LPW
CCT:	2700K, 3000K, 4000K, 5000K
CRI (Min):	70 CRI

ELECTRICAL

Input Voltage:	120-277V or 347-480V
Input Frequency:	50/60Hz
Power Factor:	≥ 90% at rated watts
Total Harmonic Distortion:	≤ 20% at rated watts

SURGE PROTECTION*

Standard	Optional
10kV/5kA	Secondary 10kV/5kA (R Option) or Secondary 20kV/10kA (T Option)

*Per ANSI C136.2-2018

RATINGS

Operating Temperature:	-40°C to 50°C *
Vibration:	3G per ANSI C136.31-2018
LM-79:	Testing in accordance with IES Standards

*ERL2 (32K Lumen 347-480V SKU) operates at -40°C to 45°C

CONTROLS

Dimming:	Standard-0-10V Optional-DALI (Option U)
Sensors:	Photo Electric Sensors (PE) available LightGrid Compatible

WARRANTY

5 Year (Standard)

10 Year (Optional)



UL 1598
WET LOCATIONS



Evolve® LED Roadway Lighting

Cobra Head (ERL2)

Catalog Logic

Project Name _____

Date _____ Type _____

Notes _____

ERL2

PROD. ID	VOLTAGE	LUMENS	DISTRIBUTION ³	CCT	CONTROLS PER ANSI C136.41	COLOR	OPTIONS
E = Evolve	0 = 120-277 ¹	16	A5 = Type II Narrow	27 = 2700K ²	A = 7-Pin Receptacle	GRAY = Gray	A = 4 Bolt Slipfitter ⁴
R = Roadway	H = 347-480 ¹	18	B5 = Type II Wide	30 = 3000K ²	D = 7-Pin Receptacle with Shorting Cap	BLCK = Black	B = Tether
L = Local		19	C5 = Type III	40 = 4000K	E = 7-Pin Receptacle with non-Dimming Long Life PE ⁵	DKBZ = Dark Bronze	F = Fusing
2 = Double Module	1 = 120	21	D5 = Type IV ¹⁰	50 = 5000K	Note: 0-10V control standard unless DALI Option "U" requested	WHITE = White	G = Internal Bubble Level
	2 = 208	23	E5 = Type II Enhanced Back Light			I = Optional IP66 Optical Enclosure	
	3 = 240	25				L = Tool-Less Entry	
	4 = 277	27				R = Secondary 10kV/5kA SPD	
	D = 347	28				T = Secondary 20kV/10kA SPD	
	5 = 480	30				U = DALI Programmable ^{6,7}	
		31				V1 = Field Adjustable Module ⁹	
		32				Y = Coastal Finish ⁸	
					XXX = Special Options		

¹ Not Available with Fusing

² Select 2700K or 3000K CCT for IDA approved units

³ Nominal IES Type classing subject to typical variation, individual units may differ

⁴ Lead time varies, contact Factory

⁵ Per ANSI C136.10-2017

⁶ Compatible with LightGrid

⁷ Not available in 347V, 480V or 347-480V

⁸ Recommended for installations within 750 feet from coast. Lead time varies, check with factory.

⁹ Not available with DALI "U" option

¹⁰ Forward throw distribution. Classifies as Type III for lumen codes 23-32. Review IES curve for application.

SUGGESTED HID REPLACEMENT

Approximately 21,500 -32,000 lumens to replace 400W HPS Cobra-head

Note: actual replacement lumens may vary based upon mounting height, pole spacing, design criteria, etc.

Evolve[®] LED Roadway Lighting

Cobra Head (ERL2)

Spec Tables

Project Name _____

Date _____ Type _____

Notes _____

LUMEN OUTPUT	DIST.	TYPICAL INITIAL LUMENS			WATTAGE		BUG RATINGS			TM-21-11 LXX (≥10k) @ HOURS		
		5000K/4000K	3000K	2700K	120V 277V	347V 480V	5000K/4000K	3000K	2700K	25,000 HR	50,000 HR	60,000 HR
16	A5	16000	15300	14200	114	B3-U0-G3	B3-U0-G3	B3-U0-G3	99	99	99	
	B5					B3-U0-G3	B3-U0-G3	B2-U0-G2				
	C5					B2-U0-G3	B2-U0-G3	B2-U0-G3				
	D5					B2-U0-G3	B2-U0-G3	B2-U0-G2				
	E5					B3-U0-G3	B3-U0-G3	B3-U0-G3				
18	A5	18000	17200	16000	130	B3-U0-G3	B3-U0-G3	B3-U0-G3	99	98	98	
	B5					B3-U0-G3	B3-U0-G3	B3-U0-G3				
	C5					B3-U0-G3	B2-U0-G3	B2-U0-G3				
	D5					B2-U0-G3	B2-U0-G3	B2-U0-G3				
	E5					B3-U0-G3	B3-U0-G3	B3-U0-G3				
19	A5	19000	18200	16900	140	B3-U0-G3	B3-U0-G3	B3-U0-G3	99	98	97	
	B5					B3-U0-G3	B3-U0-G3	B3-U0-G3				
	C5					B3-U0-G3	B3-U0-G3	B2-U0-G3				
	D5					B2-U0-G3	B2-U0-G3	B2-U0-G3				
	E5					B3-U0-G3	B3-U0-G3	B3-U0-G3				
21	A5	21000	20100	18600	160	B3-U0-G3	B3-U0-G3	B3-U0-G3	94	87	85	
	B5					B3-U0-G3	B3-U0-G3	B3-U0-G3				
	C5					B3-U0-G3	B3-U0-G3	B3-U0-G3				
	D5					B2-U0-G3	B2-U0-G3	B2-U0-G3				
	E5					B3-U0-G3	B3-U0-G3	B3-U0-G3				
23	A5	23000	22000	21300	177	B3-U0-G3	B3-U0-G3	B3-U0-G3	97	96	95	
	B5					B3-U0-G3	B3-U0-G3	B3-U0-G3				
	C5					B3-U0-G4	B3-U0-G4	B3-U0-G3				
	D5					B2-U0-G3	B2-U0-G3	B2-U0-G3				
	E5					B3-U0-G3	B3-U0-G3	B3-U0-G3				
25	A5	25000	24000	23200	191	B3-U0-G3	B3-U0-G3	B3-U0-G3	96	95	95	
	B5					B3-U0-G3	B3-U0-G3	B3-U0-G3				
	C5					B3-U0-G4	B3-U0-G4	B3-U0-G4				
	D5					B2-U0-G4	B2-U0-G4	B2-U0-G3				
	E5					B4-U0-G4	B4-U0-G4	B4-U0-G4				

For additional information on ERL2 IES files, please click one of the following links:

[Non-Shielded](#)

[Shielded](#)

Evolve® LED Roadway Lighting

Cobra Head (ERL2)

Spec Tables

Project Name _____

Date _____ Type _____

Notes _____

LUMEN OUTPUT	DIST.	TYPICAL INITIAL LUMENS			WATTAGE		BUG RATINGS			TM-21-11 LXX (≥10k) @ HOURS		
		5000K/4000K	3000K	2700K	120V 277V	347V 480V	5000K/4000K	3000K	2700K	25,000 HR	50,000 HR	60,000 HR
27	A5	27000	25900	25100	212	B4-U0-G4	B4-U0-G4	B3-U0-G3	96	94	94	
	B5					B3-U0-G3	B3-U0-G3	B3-U0-G3				
	C5					B3-U0-G4	B3-U0-G4	B3-U0-G4				
	D5					B2-U0-G4	B2-U0-G4	B2-U0-G4				
	E5					B4-U0-G4	B4-U0-G4	B4-U0-G4				
28	A5	28000	26800	26000	223	B4-U0-G4	B4-U0-G4	B4-U0-G4	96	94	93	
	B5					B3-U0-G4	B3-U0-G3	B3-U0-G3				
	C5					B3-U0-G4	B3-U0-G4	B3-U0-G4				
	D5					B3-U0-G4	B3-U0-G4	B2-U0-G4				
	E5					B4-U0-G4	B4-U0-G4	B4-U0-G4				
30	A5	30000	28800	27900	242	B4-U0-G4	B4-U0-G4	B4-U0-G4	95	93	92	
	B5					B3-U0-G4	B3-U0-G4	B3-U0-G4				
	C5					B3-U0-G4	B3-U0-G4	B3-U0-G4				
	D5					B3-U0-G4	B3-U0-G4	B3-U0-G4				
	E5					B4-U0-G4	B4-U0-G4	B4-U0-G4				
31	A5	31000	29700	28800	252	B4-U0-G4	B4-U0-G4	B4-U0-G4	95	93	92	
	B5					B3-U0-G4	B3-U0-G4	B3-U0-G4				
	C5					B3-U0-G4	B3-U0-G4	B3-U0-G4				
	D5					B3-U0-G4	B3-U0-G4	B3-U0-G4				
	E5					B4-U0-G4	B4-U0-G4	B4-U0-G4				
32	A5	32000	30700	29700	265	B4-U0-G4	B4-U0-G4	B4-U0-G4	94	91	90	
	B5					B3-U0-G4	B3-U0-G4	B3-U0-G4				
	C5					B3-U0-G4	B3-U0-G4	B3-U0-G4				
	D5					B3-U0-G4	B3-U0-G4	B3-U0-G4				
	E5					B4-U0-G4	B4-U0-G4	B4-U0-G4				

For additional information on ERL2 IES files, please click one of the following links:

[Non-Shielded](#)

[Shielded](#)

Evolve® LED Roadway Lighting

Cobra Head (ERL2)

Photometric Plots

Project Name _____

Date _____ Type _____

Notes _____

ERL2
Type II Narrow

32,000 Lumens
5000K
ERL2_32A550____.IES

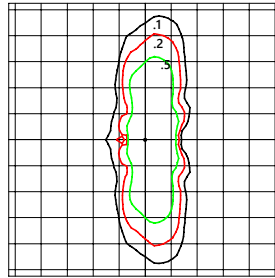

- Mounting Height at 30'
- Initial Footcandle at Grade

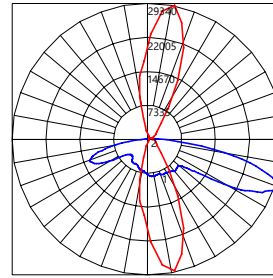

- Vertical plane at max Cd horiz. angle 80°
- Horizontal cone at max Cd vert. angle 68°

ERL2
Type II Wide

32,000 Lumens
5000K
ERL2_32B550____.IES

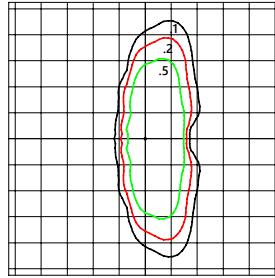

- Mounting Height at 30'
- Initial Footcandle at Grade

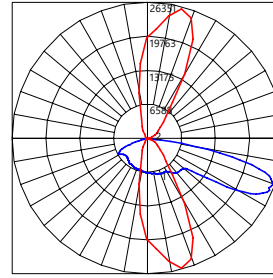

- Vertical plane at max Cd horiz. angle 75°
- Horizontal cone at max Cd vert. angle 70°

ERL2
Type III

32,000 Lumens
5000K
ERL2_32C550____.IES

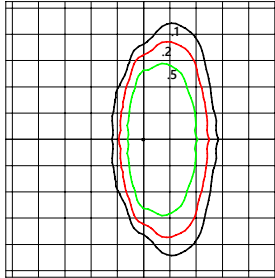

- Mounting Height at 30'
- Initial Footcandle at Grade

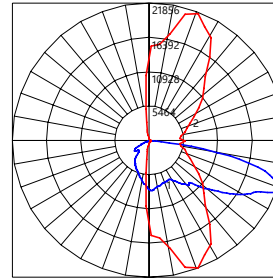

- Vertical plane at max Cd horiz. angle 70°
- Horizontal cone at max Cd vert. angle 70°

ERL2
Type III (FWT)

32,000 Lumens
5000K
ERL2_32D550____.IES
Forward Throw

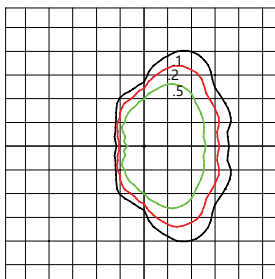

- Mounting Height at 30'
- Initial Footcandle at Grade

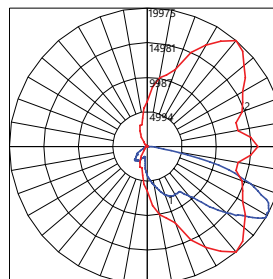

- Vertical plane at max Cd horiz. angle 50°
- Horizontal cone at max Cd vert. angle 59°

ERL2
Type II Medium

32,000 Lumens
5000K
ERL2_32E550____.IES

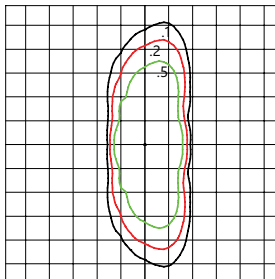

- Mounting Height at 30'
- Initial Footcandle at Grade

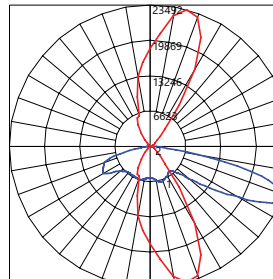

- Vertical plane at max Cd horiz. angle 75°
- Horizontal cone at max Cd vert. angle 67°

Evolve® LED Roadway Lighting

Cobra Head (ERL2)

Mounting & Accessories

Project Name _____

Date _____ Type _____

Notes _____

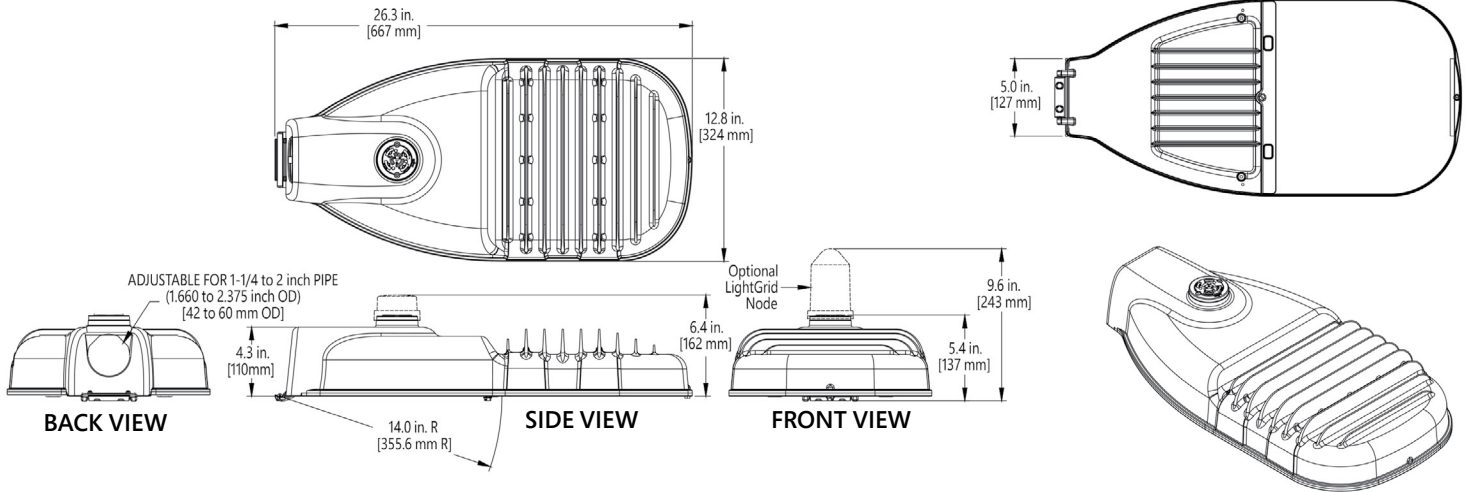

MOUNTING

- Adjustable for 1.25 to 2 in. nominal mounting pipe (1.660 to 2.375 inch OD)
- Integral diecast mounting pipe stop
- Slipfitter with +/- 5 degrees of leveling adjustment

EFFECTIVE PROJECTED AREA

- 0.57 sq ft max (0.053 sq m)

WEIGHT

- 24.0 lbs (10.9 kgs)

ACCESSORIES

SAP Number	Part Number	Description
93029237	PED-MV-LED-7	ANSI C136.41 Dimming PE, 120-277V
93029238	PED-347-LED-7	ANSI C136.41 Dimming PE, 347V
93029239	PED-480-LED-7	ANSI C136.41 Dimming PE, 480V
28299	PECOTL	Long Life PE 120-277V
93147530	PECHTL	Long Life PE 347-480V
73251	SCCL-PECTL	Shorting Cap

NETWORK LIGHTING CONTROLS



Current's **LightGrid™** Outdoor Lighting Control System is designed for Street and Roadway Applications. It enables remote monitoring, control, and asset management of a single fixture or a group of fixtures through a web enabled Central Management System.



HOUSE SIDE SHIELDS

ERLC SHIELDS

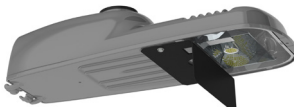
Product Code:	93110037	Description:	ELSHS-ERLC-BLCK
Product Code:	93110038	Description:	ELSHS-ERLC-GRAY
			

ERL1 SHIELDS

Product Code:	93024487	Description:	ELSHS-ERL1-BLCK
Product Code:	93046386	Description:	ELSHS-ERL1-GRAY
Product Code:	93068998	Description:	ELSHS-ERL1-DKBZ
			

ERL2 SHIELDS

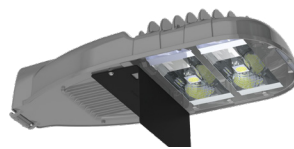
Product Code:	93070722	Description:	ELSHS-ERL2-BLCK
Product Code:	93085564	Description:	ELSHS-ERL2-GRAY
Product Code:	93096747	Description:	ELSHS-ERL2-DKBZ
			

STREET SIDE SHIELDS

ERLC SHIELDS

Product Code:	93132372	Description:	ELSFS-ERLC-BLCK-10
Product Code:	93132373	Description:	ELSFS-ERLC-BLCK-15
Product Code:	93134760	Description:	ELSFS-ERLC-BLCK-20
			

ERL1 SHIELDS

Product Code:	93092595	Description:	ELSFS-ERL1-BLCK-10
Product Code:	93108740	Description:	ELSFS-ERL1-GRAY-10
Product Code:	93092906	Description:	ELSFS-ERL1-BLCK-15
Product Code:	93105144	Description:	ELSFS-ERL1-GRAY-15
Product Code:	93088130	Description:	ELSFS-ERL1-BLCK-20
Product Code:	93088131	Description:	ELSFS-ERL1-GRAY-20
			

ERL2 SHIELDS

Product Code:	93132955	Description:	ELSFS-ERL2-BLCK-20
Product Code:	93132986	Description:	ELSFS-ERL2-GRAY-20
			



SIDE SHIELDS (L&R)

Shipped as a kit - L & R can be used independently

ERLC SHIELDS

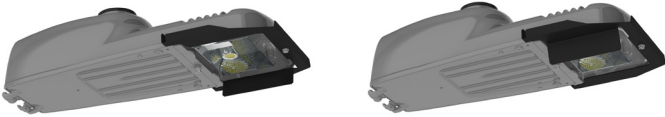
Product Code:	93132374	Description:	ELS-ERLC-LEFTRIGHTSIDEKIT-BLCK-10
			

ERL1 SHIELDS

Product Code:	93118695	Description:	ELS-ERL1H-LEFTRIGHTSIDEKIT-BLCK-10
			

ERL2 SHIELDS

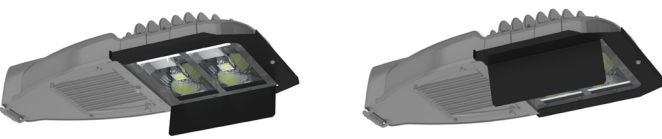
Product Code:	93132989	Description:	ELS-ERL2-LEFTRIGHTSIDEKIT-BLCK-10
			

FOOTNOTES:

- 1) 10 = 1" Shield Depth; 15 = 1.5" Shield Depth; 20 = 2" Shield Depth
- 2) Black is recommended to reduce potential for glare coming off of the shield
- 3) Use "House Side" Shield to block light trespass behind the pole
- 4) Use "Street Side" / Front Shield to block light trespass across the street